

ENDUROGEL 12V80Ah

Valen ENDUROGEL battery is rechargeable, deep cycle, Valve Regulated Lead Acid (VRLA). Thanks to its Catalyst Life Extender, the Valen ENDUROGEL stands unique and apart from any other Gel battery. The Catalyst substantially reduces sulphation, thermal runaway, delamination and battery dry out; all major killers of VRLA batteries. By recombining hydrogen and oxygen ions, the Catalyst Life Extender can provide a longer, fuller and greener life. Valen ENDUROGEL batteries are ideal for use within Communications, solar and other mission critical cyclic applications.

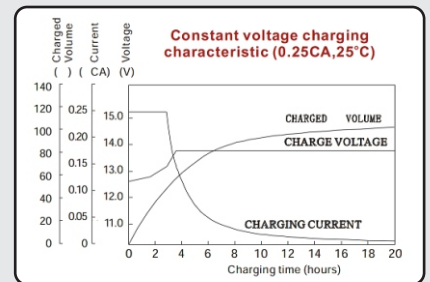
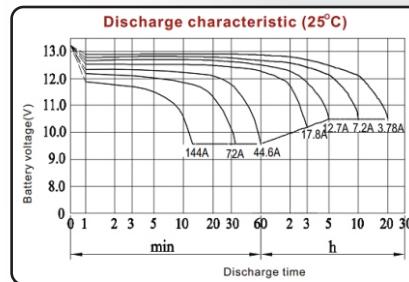
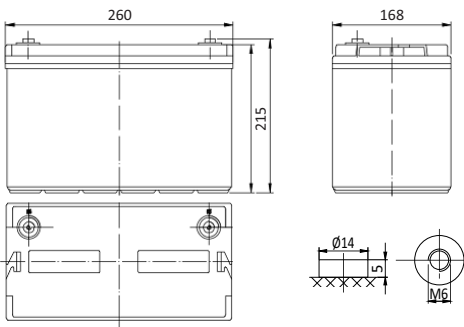

SPECIFICATIONS

Voltage	12 Volt nominal
Number of cell	6
Design life	12 years
Nominal Capacity 25°C	
100Hr rate (10.5V)	77Ah
20Hr rate (10.5V)	70Ah
10Hr rate (10.5V)	64.8Ah
5Hr rate (10.5V)	54.5Ah
Dimensions	260(L)x168(W)x215(H)
Weight	24Kg
Plates	Heavy duty
Terminal	Insert - M6
Container/cover	ABS
Charge voltage	Cycle: 14.10-14.40V at 25°C Float: 13.50-13.80V at 25°C
Internal Resistance	7mΩ 25°C - Fully charged Battery
Electrolyte	Thixotropic Gel - Sulphuric acid
Vent	Self-sealing
Operating temperature:	-20°C to +60°C

(However it is recommended that the batteries be operated in the temperature range of 20 to 30°C to obtain full life and optimum performance.)

Discharge Constant Current (Amperes at 25°C)

End Point Volts/Cell	15min	30min	1h	3h	5h	10h	20h	100h
1.75V	86.1	60.5	38.4	16.5	10.9	6.48	3.5	0.77

Discharge Constant Power (Watts at 25°C)

End Point Volts/Cell	15min	30min	1h	3h	5h	10h	20h
1.75V	958	690	442	195	129	77.7	42.2

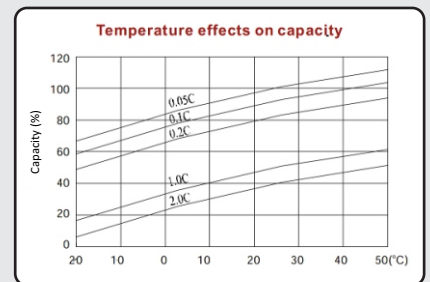
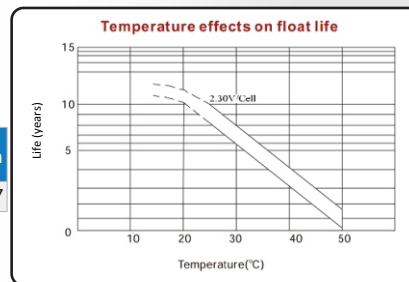
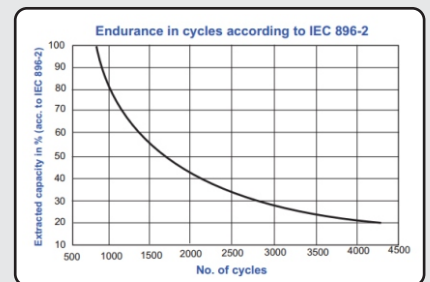
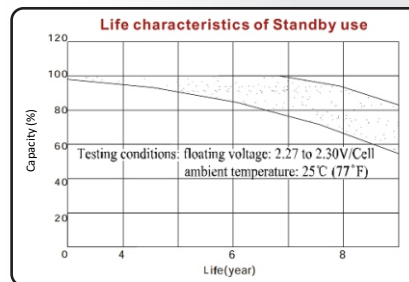
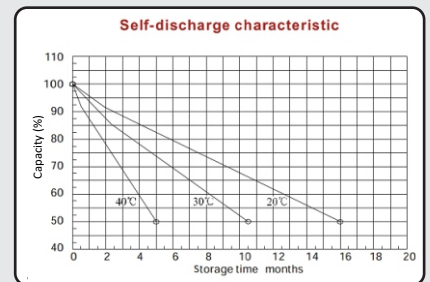
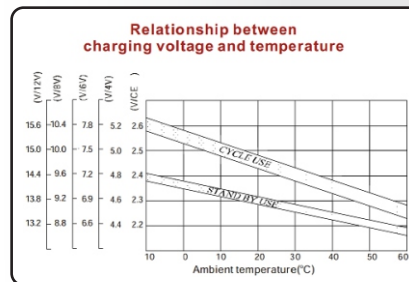

*Although the Catalyst extends battery life at high temperatures it is not expected to change the momentary delivery of the current. The benefit of having the Catalyst in batteries will be shown over time.

AUSTRALIA:

1300 734 253
sales@valen.com.au
valen.com.au

NEW ZEALAND:

0800 734 253
sales@valen.co.nz
valen.co.nz



End-to-End Solution Provider of Industrial Batteries & Energy Storage